

TP 250 DIMENSIONS

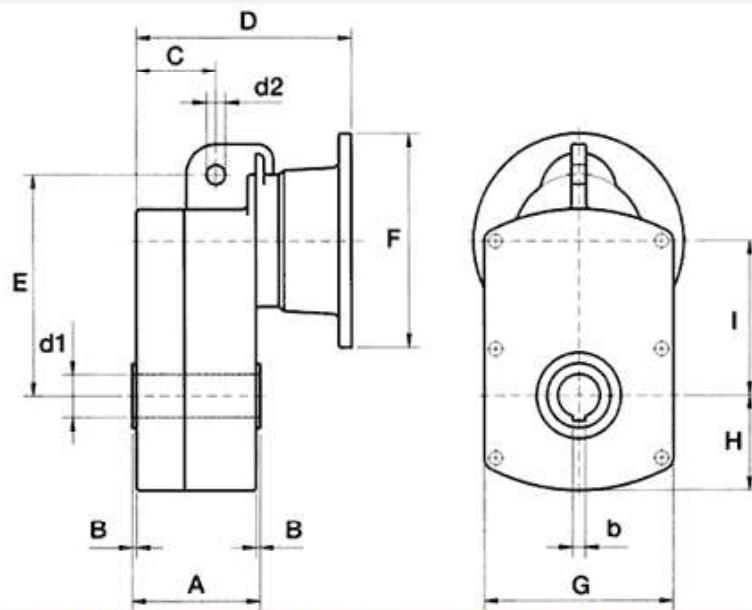

TYPE	A	B	C	D	E	F	G	H	I	d1 H7	d2	b	weight	oil quantity
TP250	118	2	76	196 206	207	200 250	180	88	145	40	18	12	30 kg	1,0 lt

EXECUTION WITH BROACHED QUILL DIN 5482

TYPE	Ø INT.	Ø EXT.	Z	MOD.
TP250	41 H11	45 H12	22	2

DIMENSIONS OF REACTION ARM CONNECTION

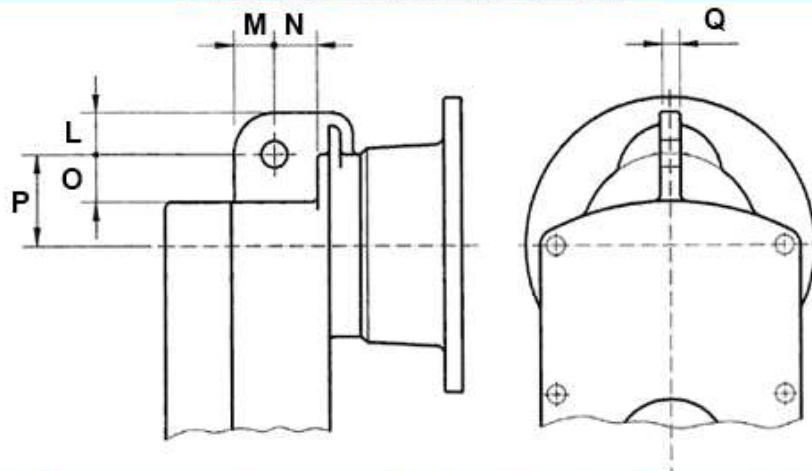

TYPE	L	M	N	O	P	Q
TP250	33	30	28	32	62	16

DIMENSIONS OF REACTIONS PADS

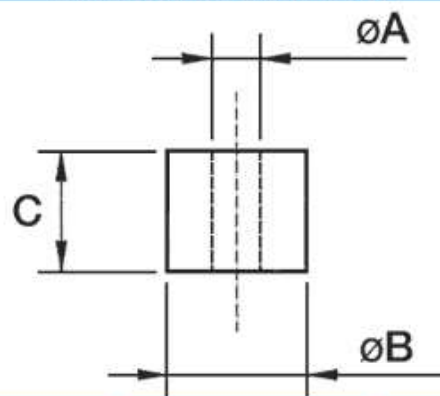

TYPE	Ø A	Ø B	C
TP250	17	50	40

The dimensions are in millimeters