

załącznik nr 1

A-A  
PRZEKROJ PŁOZY

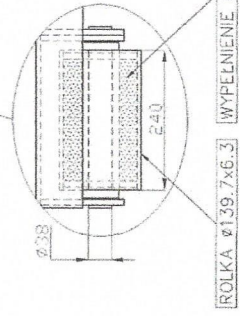
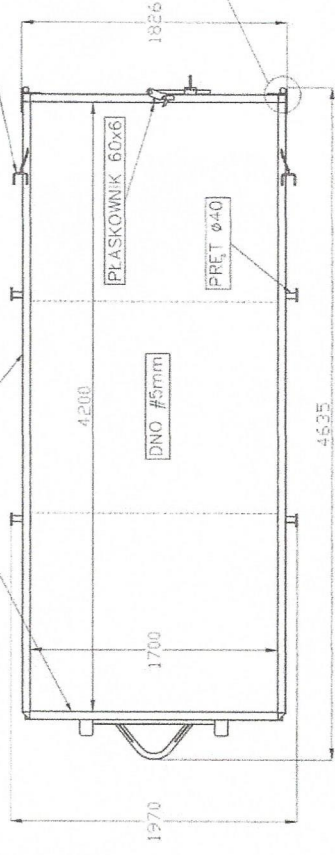
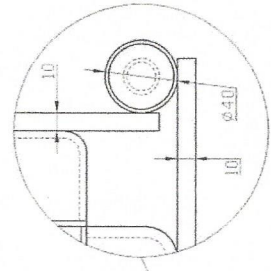
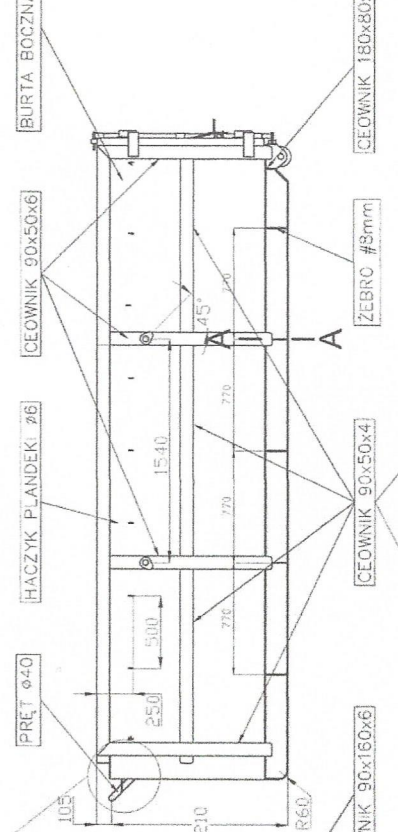
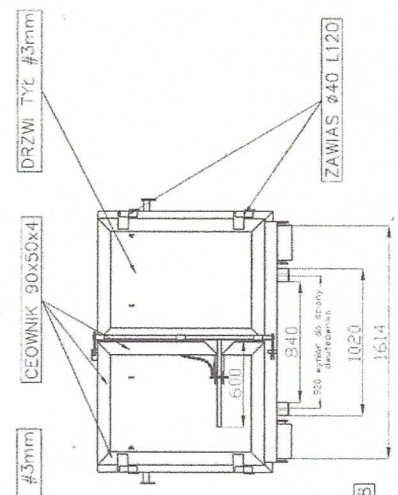
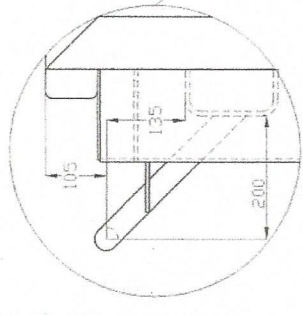
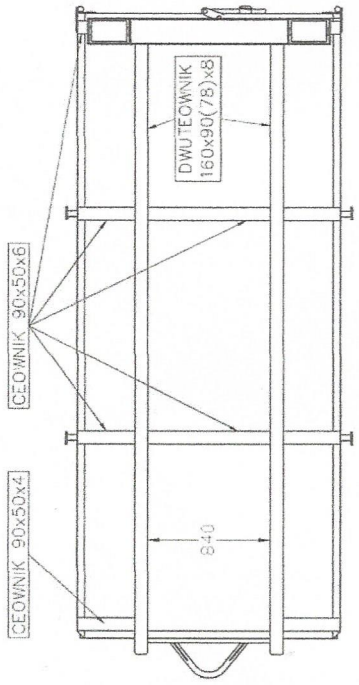
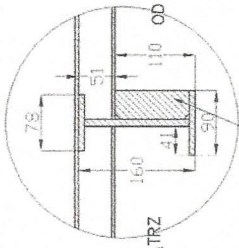

<b>PRINOX</b>	Nr zlecenia:	21	Rys.nr:	1
	Wykonat:	Karbowiczek M.	Data:	
<b>Eko-MTK</b>	Spawal:		Data:	
<b>Kontener</b>	Montował:		Data:	
<b>8 m³</b>	Sprawdził:		Data:	

<b>KONTENER 8 m³ AISI304</b>
Przystosowany do transportu samochodem typu "nakowiec"
Przystosowany do transportu samochodem typu "bramowiec"
Haczyki do planek po całym obwodzie (co 500mm)
Pojemność kontenera 8.2 m³